

LPA Concepts

10W GSM MULTICARRIER AMPLIFIER MODULE

Customer : -	LPA-RPA2-10-925M-960M-28-03
LPA CODE : P2020	
<p>925-960MHz; 10Wav/100Wpeak power compatible 2G-3G-4G on GSM</p> <p>Low power consumption: 85W @ 10Wave</p> <p>44dB Gain</p> <p>Internal / External ALC</p> <p>Monitoring / Control through RS485 bus</p> <p>RoHs compliant Directive 2015/863</p>	

Electrical characteristics: 50 ohms; +28V; -25°C to +75°C (1)

Ref	parameter	conditions	note	min	typ	max	units
1	Bandwidth			925		960	MHz
2	Instantaneous bandwidth	925-960MHz		7			MHz
3	Gain	942.5MHz			44		dB
4	Gain variation vs frequ.	925-960MHz				0.5	dBpp
5	Gain variation vs temp	942.5 MHz, -25°C à +75°C				1	dB
6	Input return loss	50 ohms				-18	dB
7	Output return loss	50 ohms				-18	dB
8	Peak power	10 equidistant CW tones with peaked phases ; -50dBc IMD		80	100		Wp
9	Intermodulation 2 tones CW	f1= 937MHz +37dBm f2= 948MHz +37dBm			-73	-68	dBc
10	Intermodulation 2 tones CW	f1= 925.0MHz +37dBm f2= 925.2MHz +37dBm			-73	-68	dBc
11	Intermodulation 2 tones CW	f1= 959.8MHz +37dBm f2= 960MHz +37dBm			-73	-68	dBc
12	Reverse IMD	f1 forward =937MHz +37dBm f2 reverse = 948MHz +7dBm				-73	dBc
13	Intermodulation 2 GMSK carriers	+35dBm each	3,4			-71	dBc
14	Intermodulation 2 8PSK carriers	+35dBm each	3,4			-71	dBc
15	Intermodulation 4 8PSK carriers	+32dBm each	3,4			-68	dBc
16	Intermodulation 8 8PSK carriers	+29dBm each	3,4			-65	dBc

1. unless otherwise specified
2. 0°C to +75°C
3. 915MHz< intermod <970MHz
4. ResBW=10kHz, VBW=100kHz, Span=2MHz, Rms aver=10

Specifications and information are subject to change without notice

LPA Concepts

Electrical characteristics (continued): 50 ohms; +28V; -25°C to +75°C (1)

Ref	parameter	conditions	note	min	typ	max	units
17	Intermodulation derating	<915MHz & >970MHz				5	dB
18	Intermodulation derating	-25°C <temp< 0°C				3	dB
19	EVM rms	1 8PSK carrier at +40dBm			1		%
20	Max power WCDMA	Spectrum emission mask 1 WCDMA TM1 64DPCH (PAR=10.3dB)	2	10	13		W
21	Mixed mode spurious	1WCDMA @5W + 2 GSMK@2.5W each (10W composite with PAR<10dB)	2			-36	dBm
22	Harmonic suppression	1 carrier @ 10Wav	5		-40		dBc
23	Noise figure	918-925MHz			16		dB
24	Noise figure	880-915MHz			16		dB
25	Voltage supply			27	28	29	V
26	Consumption idle	28V			1.4	1.6	A
27	Consumption at 10W _{CW}	28V			3.5	3.9	A
28	Consumption at 10W _{10dBPAR}	28V			2.9	3.2	A
29	ALC output level	+40dBm CW			2		V
30	ALC output rise time	90% rise time 0-40dBm step			1		ms

5. all harmonics

Maximum ratings & Protections

Ref	characteristic	description	remarks
1	Output mismatch	$\infty : 1$ at 10W output	Infinite duration, no shut down
2	Overvoltage	Shut down if supply>32V	Transients<40V
3	Overcurrent	Shut down if current> 6.0A	Output power > 35W
4	Temperature	Shut down if temp>90°C	Auto recovery (at 80°C)

Communication & software

Ref	parameter	designation	conditions	Remarks
1	RS485 communication		Half duplex	2 wire ; 9600 bauds
2	Amplifier address		hA0	Hex value, fixed
3	Instruction set	TKMA20001	Programmers guide	

Controls

Ref	parameter	designation	conditions	Remarks
1	ON/OFF	ONOFF		through RS485 see programmers guide instruction set
2	Int ALC on/off	ALC		
3	Int ALC level set	ALCLVL	+33dBm to +44dBm	
4				

Monitoring

Ref	parameter	designation	conditions	Remarks
1	temperature	M1	Hot spot temperature (9)	through RS485 see programmers guide instruction set
2	Forward output power	M2		
3	Reverse output power	M3		

6. housing temperature – hot spot temperature $\leq 10^\circ$ @5W

Specifications and information are subject to change without notice

LPA Concepts

Alarms

Ref	parameter	designation	conditions	Remarks	location
1	Main amplifier alarm	A1		Alarm but no action	RS485
2	Auxiliary supply alarm	A2		Alarm but no action	RS485
3	Overtemp shut down alarm	A3	Temp > 90°C	Shut down	RS485
4	Overcurrent/overvoltage	A4	I>6.3A V>32V	Shut down	RS485
5	Forward output power alarm	A5	Pforward>+43dBm	Alarm but no action	RS485
6	Reverse output power alarm	A6	Preverse>+30dBm	Alarm but no action	RS485
7	Full status			See instruction set	RS485
8	Alarm voltage	ALA	ALA=A1+A2+A3+A4+A5+A6	Open collector +5V when no alarm; 0V when alarm	Connector pin 5

DC Connector (Molex Microfit 10 contacts male)

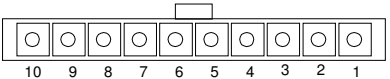
Pin description			Connector pinout
Pin 1 : RS485 TxRx-	Pin 5 : ALA	Pin 9 : +28V	
Pin 2 : RS485 TxRx+	Pin 6 : N/C	Pin 10 : +28V	
Pin 3 : Gnd	Pin 7 : Gnd		
Pin 4 : ALC	Pin 8 : Gnd		

Mechanical

Ref	characteristic	description	remarks
1	housing size	151mm x 91mm x 22.9mm	
2	housing finish	electroless nickel	
3	mounting	8 M4 screws	
4	RF connectors	SMA	
5	DC connector	Molex 43650-1012	

RPA2 package outline :

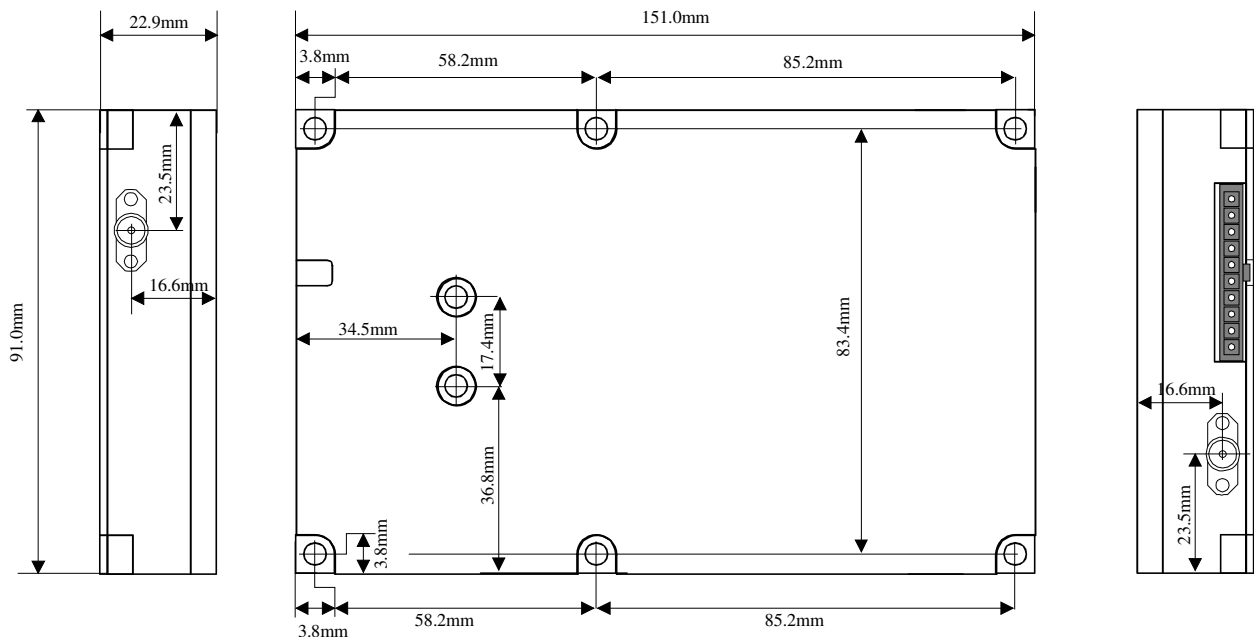

Specifications and information are subject to change without notice

LPA Concepts

TYPICAL PERFORMANCE

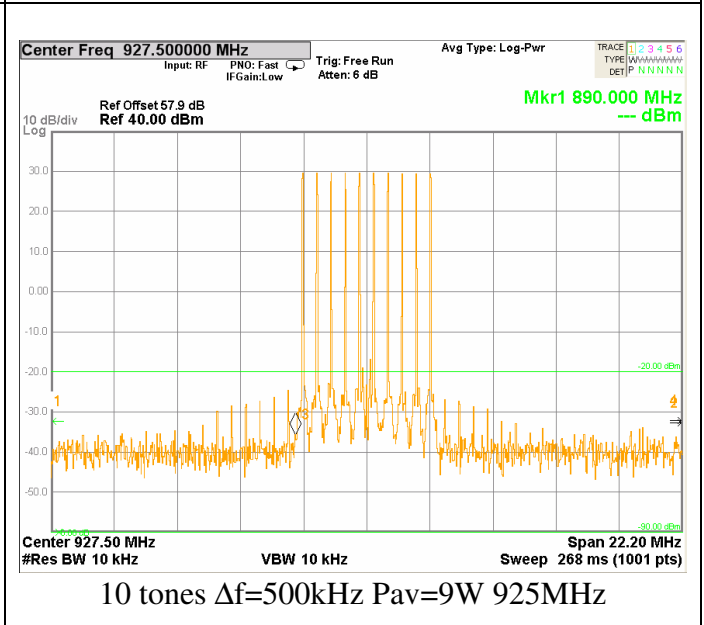
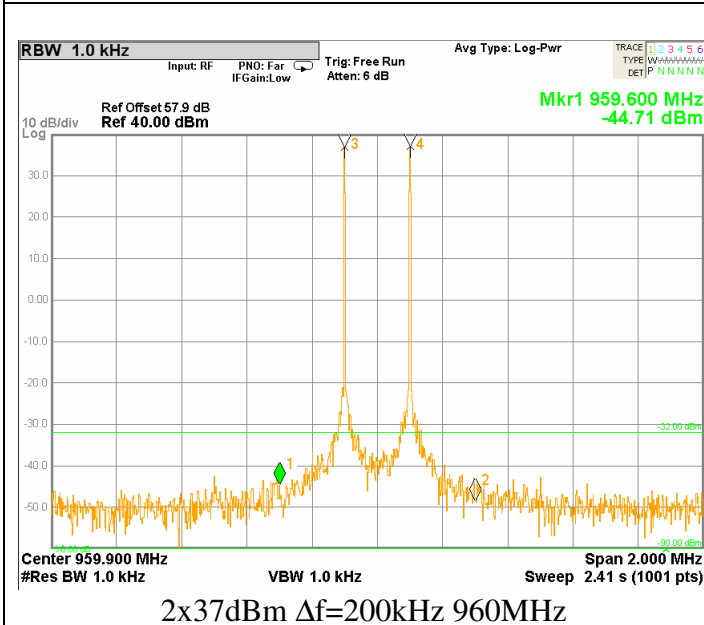
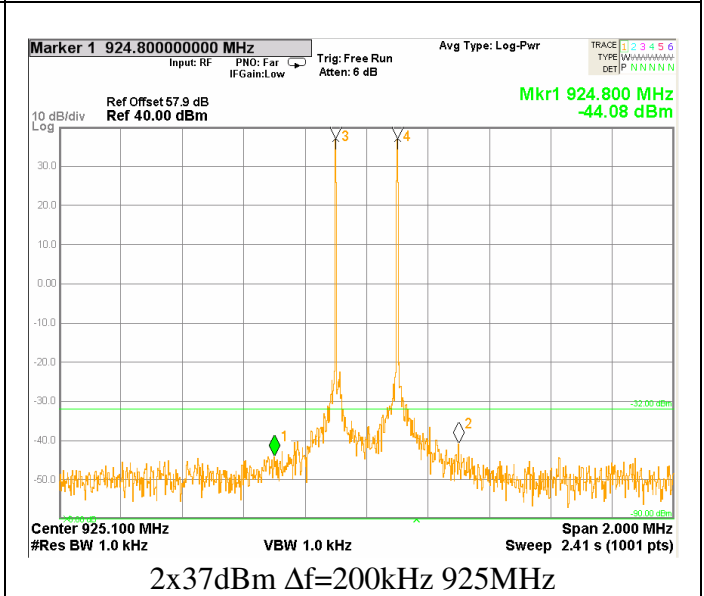
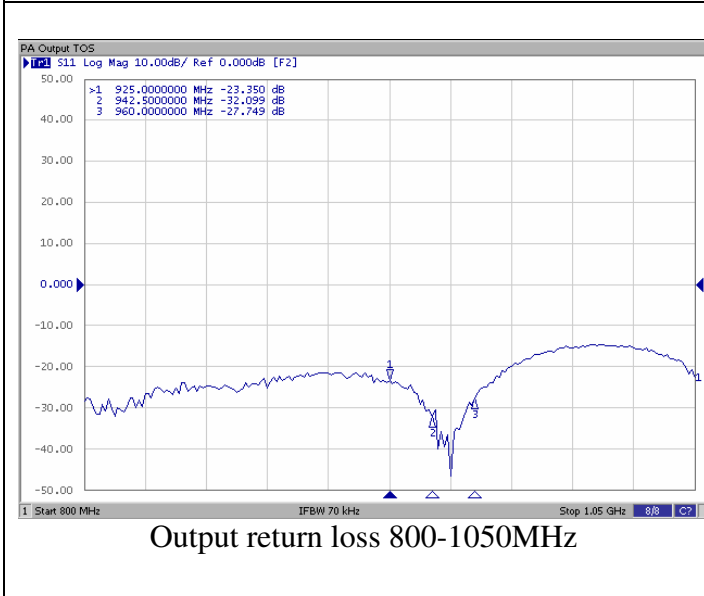
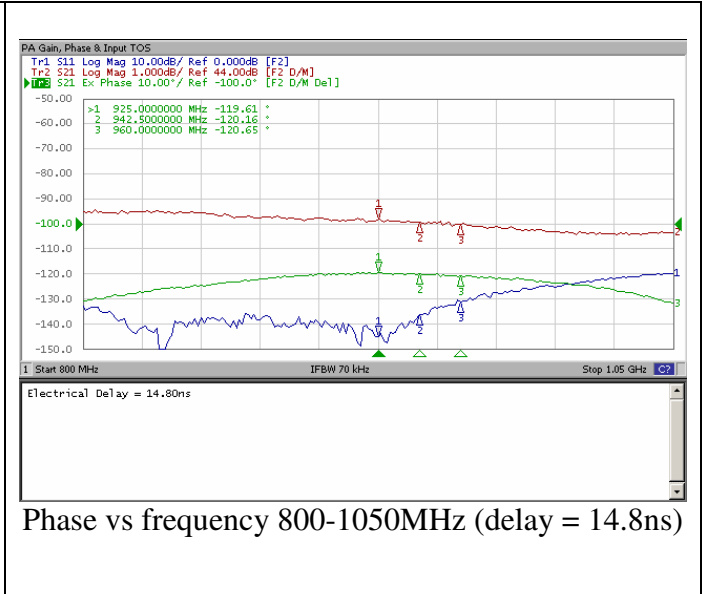
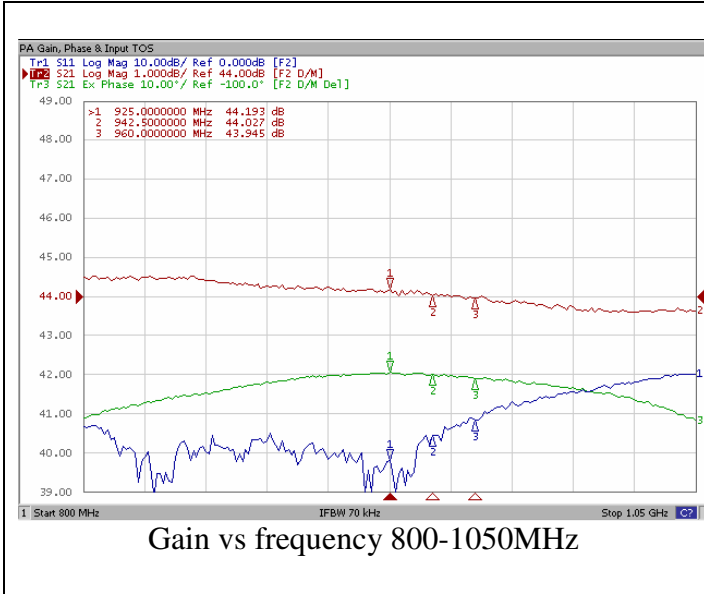

Specifications and information are subject to change without notice

